

WATERPROOFING CONSTRUCTION JOINTS

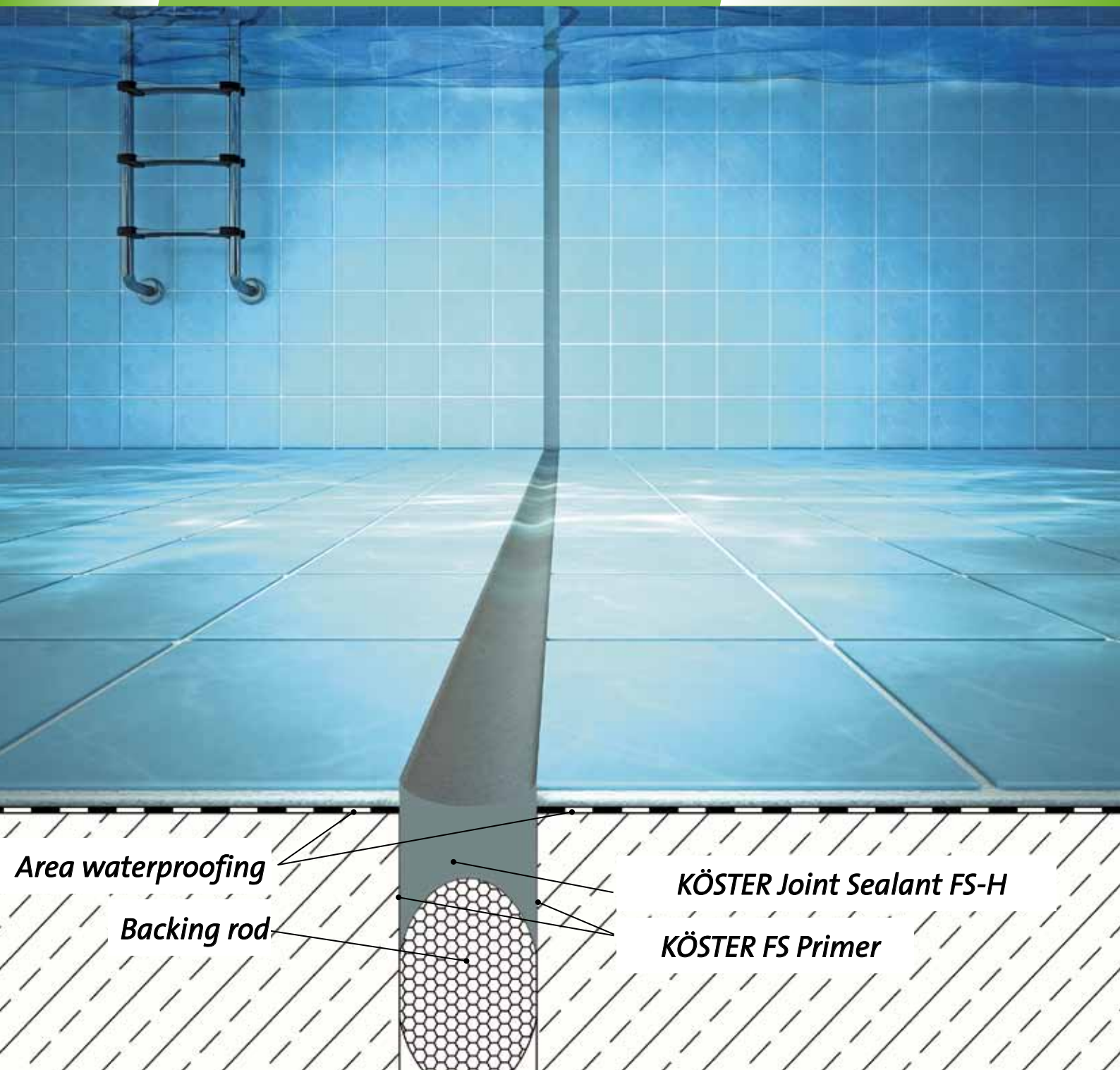

Area waterproofing

Backing rod

KÖSTER Joint Sealant FS-H



KÖSTER FS Primer

Contents

Basics

| | |
|--|---|
| Connective, loadable and resilient: Joints in building construction | 3 |
| Joint types | 3 |
| Joint waterproofing | 4 |
| Important properties of waterproofing materials | 5 |
| KÖSTER Joint waterproofing solutions in practice | 5 |
| Substrate preparation | 5 |

Application

| | |
|---|---|
|  Joint waterproofing with KÖSTER Joint Sealant FS | 6 |
|  Joint waterproofing with KÖSTER Joint Tape | 7 |
|  Joint waterproofing with KÖSTER Special Joint Tape | 9 |

Special waterproofing applications

| | |
|--|----|
|  Joint waterproofing and chemical attack | 11 |
| Retroactive joint waterproofing with KÖSTER PUR Gel | 11 |
| Curtain injection with KÖSTER PUR Gel | 11 |

Good to know

| | |
|---|----|
| Case study: Secure waterproofing against pressurized water | 12 |
| Reliable waterproofing for pipe and cable penetrations | 14 |

Connective, loadable and resilient: Joints in building construction



Joints connect building parts and elements that are made from different materials, enable movement and settling of the construction, and contribute to the acoustic insulation of a building. Construction joints are found in new construction, in precast construction and existing buildings. Joints must be properly planned and installed with respect to thermal transmission and air tightness so that they do not become a weak point in the building.

Joint types

There are different types of joint specifications depending on the exposure and the field of application. Generally there are joints for absorbing movement and connection joints. With “joints for absorbing movement” we mean dilation joints, expansion joints, settlement joints, dummy joints, pressed joints, and contraction joints, (see the table on page 4). These joints are necessary to avoid damage to the construction in the form of deformation and cracking due to differences in the expansion characteristics of the different construction materials in adjacent building elements.

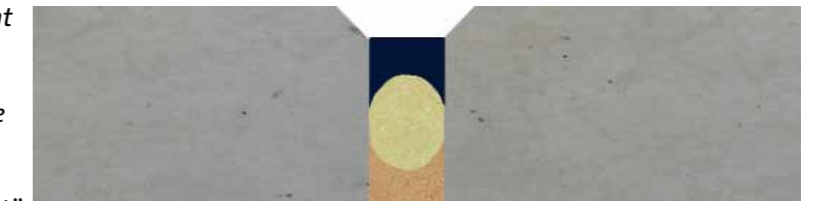

Moving joint, waterproofed with KÖSTER Joint Sealant FS



Connection joints are joints between two different types of materials as in the case of between windows and doors and masonry, and sanitary joints that are constantly exposed to water. Movement also occurs due to the different swelling, expansion, and contraction characteristics of a construction material.

Connection joints between similar or different materials require a dependable and resilient waterproofing that can withstand movements in the structural member as well as heavy operational demands.

Joint Waterproofing

The success of a joint waterproofing not only depends on the external circumstances, but starts at the planning phase of the construction project. The choice of a proper jointing material is decisive for its durability and life cycle expectancy. Another key factor for a durable waterproofing of a joint is the surface preparation. The adhesion of the material to the joint flanks is of equal importance.

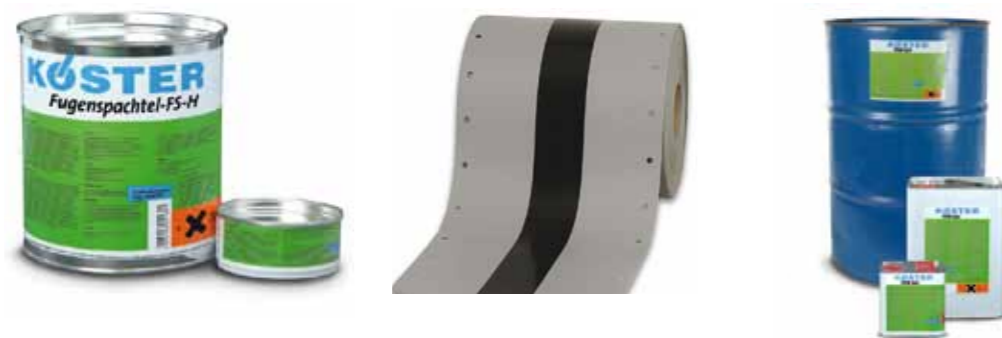

Pourable sealing compounds, joint materials in paste form, joint tapes, and injection systems (including injection hoses) are essentially the materials available for successfully waterproofing moving joints.

| Joint type | | Depiction | Function | Waterproofing solution |
|------------------|-------------------|-----------|---|--|
| Cold Joint | | | boundary between concreting steps, for example the wall / floor joint | KÖSTER Special Joint Tape KÖSTER Deuxan®2C |
| Running joints | Movement joint | | reciprocal movement possibilities for separate construction members in different directions | KÖSTER Joint Sealant FS KÖSTER Joint Tape KÖSTER PU Joint Sealant KÖSTER Special Joint Tape |
| | Expansion joint | | Movement in the perpendicular to the joint flanks | KÖSTER Joint Sealant FS-H KÖSTER PU Joint Sealant KÖSTER Joint Tape |
| | Settlement Joint | | Movement parallel to the joint flanks | KÖSTER Joint Tape KÖSTER FS Joint Sealant |
| | Dummy joint | | Predetermined breaking point | KÖSTER Joint Sealant FS KÖSTER PU Joint Sealant |
| Specialty joints | Pressed joint | | transfer of pressure, transverse displacement can be avoided with an interlocking geometry | A special construction is necessary |
| | Contraction joint | | reduction of building element movement (i.e. contraction during curing or settlement of the building) | After curing of the concrete with KÖSTER Repair Mortar |

Important properties of waterproofing materials

Sealing compounds for joint waterproofing are distinguished by their mechanical properties and according to their type of deformability (plastic or elastic).

Elastic Waterproofing

Elastic sealing compounds move back into their original shape after being stressed due to their extensibility. Sealing compounds for expansion joints should always be made from elastic materials. The more movement a joint experiences, the higher quality the waterproofing material needs to be.

Plastic Waterproofing

With plastic waterproofing materials it is easy to create a bond to diverse substrates. Plastic sealing compounds can be used in closed joint designs such as in pipe penetrations (see page 14).

Plastic sealing compounds deform permanently after being stressed and do not return to their original shape. They have the advantage that they create practically no tension on the joint flanks.

KÖSTER Joint waterproofing solutions in practice

Movement joints must be waterproofed durably, elastically, form stable, and UV resistant. A joint waterproofing must allow for movement in the construction without causing damage to the construction itself. Movement joints up to a width of 35 mm can be waterproofed with KÖSTER Joint Sealant FS. For wider joints such as expansion and dilation joints KÖSTER Joint Tapes are used.

Substrate Preparation

All substrates must be prepared before the application of a waterproofing. The preparation of the substrate determines the quality of the system and should not be undervalued. As a general rule the substrate must be cleaned or removed down to a solid and stable base material, then leveled and primed. The substrate must be clean, solid, and dry, and free from adhesion inhibiting materials such as waxes, oils, and old coatings.



Sandblasted surface



Cleaned joint flanks

Joint waterproofing with KÖSTER Joint Sealant FS



A commonly used method for waterproofing joints is to fill them with an elastic material. KÖSTER Joint Sealant FS-H is a self leveling, rubbery-elastic sealing compound with high chemical resistance and is therefore the ideal material to waterproof horizontal joints in heavy construction, in foundations, waste water treatment plants, garages, tunnels, etc. KÖSTER Joint Sealant FS-V has a putty-like consistency for vertical and horizontal joint waterproofing.

Application



The joint flanks are beveled before the application of the Joint Sealant. The bevel must be at least 10 mm wide and in a 45° angle.



To avoid damages to the Joint Sealant caused by movement in multiple directions, the Joint Sealant should only bond to two joint flanks. For this reason a backing is installed for example with quartz sand or a foam PE backing rod. This eliminates the possibility of adhesion to three flanks.

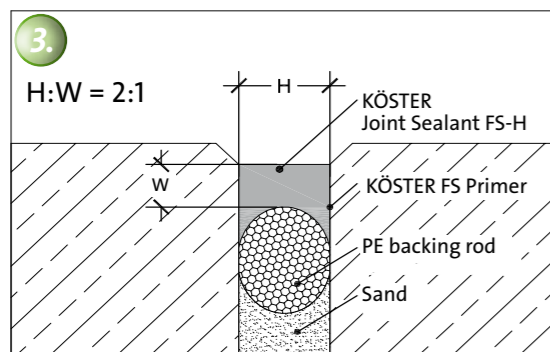

The Joint Sealant should be installed so that the ratio of joint height: width corresponds to the norm requirement. A detailed table is provided in the Technical Guideline.

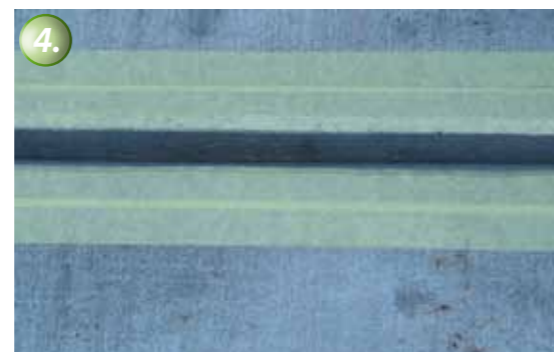

The sides of the joint are taped to achieve a clean and orderly application.



Absorbent substrates must be primed with KÖSTER FS Primer twice. Non-absorbent substrates are primed once.



The joint is filled approximately 2 hours after applying the KÖSTER FS Primer.



The Joint Sealant is smoothed, for example with a spackle. The tape should be removed before the Joint Sealant has hardened.



KÖSTER Joint Sealant FS-H in its cured state.

Joint waterproofing with KÖSTER Joint Tapes



KÖSTER Joint Tape is a thermoplastic tape for waterproofing expansion joints. It comes in widths of 20 cm (for 12 cm wide joints) and 30 cm (for up to 20 cm wide joints). KÖSTER Joint Tapes are UV stable; highly elastic and can resist extreme joint movements.

The Joint Tape System consists of the KÖSTER Joint Tape, KÖSTER KB-Pox® Adhesive, an epoxy based high performance adhesive.

Application

Initially both sides of the joint are masked with tape.





2. KÖSTER Joint Tape 20 is embedded into the adhesive at least 4 cm on each side (the KÖSTER Joint Tape 30 at least 5 cm). The adhesive is applied 2 cm farther onto the substrate.



3. The two components of the KÖSTER KB-Pox® Adhesive are mixed according to the Technical Guideline until a homogenous grey color is reached. The Adhesive is then spread onto both sides of the joint 2-3 mm thick.



4. The KÖSTER Joint Tape is embedded into the fresh adhesive. Immediately thereafter the second layer of adhesive is applied.



5. The masking tape on both sides of the KÖSTER Joint Tape must be removed before the KÖSTER KB-Pox® Adhesive has begun to cure, so that a clean boundary results. The KÖSTER KB-Pox® Adhesive must cure for 24 hours.



6. For optical reasons the black tape in the center of the KÖSTER Joint Tape can be covered with KÖSTER KB-Pox® Adhesive and removed before the Adhesive begins to cure.



7. After the KÖSTER KB-Pox® Adhesive has cured for 24 hours the area waterproofing can be applied overlapping the KÖSTER Joint Tape.

KÖSTER Special Joint Tape

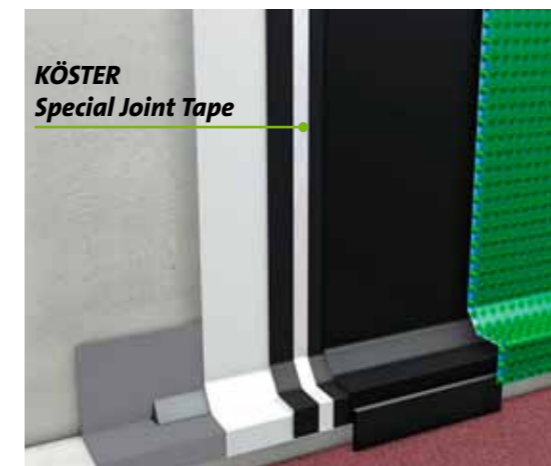

KÖSTER Special Joint Tape is a cold self adhesive waterproofing tape for integration into the area waterproofing using KÖSTER polymer modified bitumen thick film sealants and KÖSTER KSK membranes.

Fields of application: waterproofing and permanent bridging of cold joints, movement joints, and expansion joints, (see "joints for absorbing movement"). KÖSTER Special Joint Tape is internally reinforced with a highly tear-resistant fiber mesh, withstands high stresses, and is laminated with a 5 cm wide aluminum strip which faces away from the building.

Application



The substrate is first primed, for example with KÖSTER KBE Liquid Film. After curing the KÖSTER Special Joint Tape is applied. KÖSTER Special Joint Tape is cold applied, self adhesive and is simple to use.



An area waterproofing such as KÖSTER Deuxan® 2C is easily overlapped onto the KÖSTER Special Joint Tape.



Not only polymer modified bitumen thick film sealants, but also cold applied, self adhesive KÖSTER KSK Membranes are suitable for combining with KÖSTER Special Joint Tape for a reliable waterproofing.

KÖSTER INJECTION SYSTEMS

- waterproofing of active leakages
- structural repair
- filling of voids

Request
information
now!

KÖSTER
Waterproofing Systems

Special waterproofing applications

Joint waterproofing and chemical attack

Joints that are exposed to acid and alkali attack require an especially durable waterproofing sealant. KÖSTER PU Joint Sealant is a permanently elastic, polyurethane based joint sealant

and is used for waterproofing horizontal joints, dummy joints, and grouting pockets in prefab construction.



KÖSTER PU Joint Sealant is chemically stable when hardened and highly resistant to organic and inorganic acids, alkalis, and will not rot.

The self leveling material is installed by pouring without a primer and expands slightly while curing, pressing itself up against the joint flanks.

Retroactive joint waterproofing with KÖSTER PUR Gel

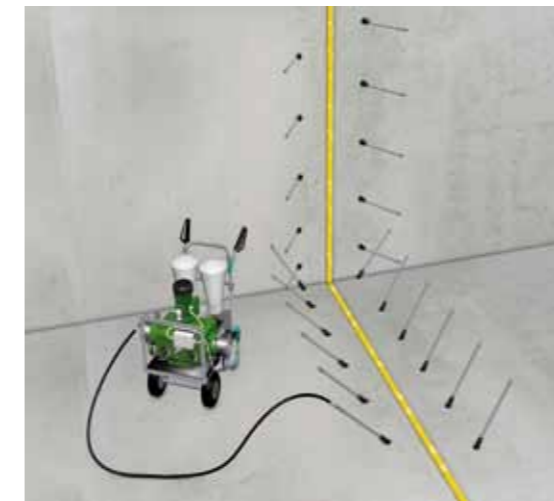

Waterproofing joints that are moist or even have water flowing through them are a special challenge, as many waterproofing sealants will not bond to wet or even moist substrates.

KÖSTER PUR Gel is injected by pressure into the joint, often allowing existing materials to be left in place. KÖSTER PUR Gel reacts with the water in the joint to form an elastic, waterproof compound. Even flowing water can be stopped with this method.



Curtain injection with KÖSTER PUR Gel



A further field of application for KÖSTER PUR Gel is the post construction waterproofing of building elements in contact with soil. This method is used where it is impossible to excavate the outside basement walls, for example in cases where the surrounding property is built upon, or close to busy streets. Also in many historical buildings or buildings with special architectural characteristics it is not possible to install a negative side waterproofing due to aesthetic concerns. In such cases a curtain injection is an effective alternative technique.

Case study: Secure waterproofing against pressurized water

The following case study shows step by step how a reliable joint waterproofing is carried out using KÖSTER Systems. It shows a swimming pool used in the muscular rehabilitation for race horses at the Veli Efendi Racetrack in Istanbul, Turkey. The expansion joints were waterproofed using KÖSTER Joint Tapes and KÖSTER FS Joint Sealants. The area waterproofing was completed with the mineral based, crystallizing waterproofing slurry KÖSTER NB 1 Grey.



The debris and remnants of the concreting work are removed.



The surface is cleaned down to a solid and stable base material. The substrate must be clean, solid, and free from adhesion inhibiting materials.



To give the KÖSTER Joint Tape more tolerance, it is pressed slightly into the joint.



Connections are made with a hot air welding gun; seams should overlap at least 2 cm.



The area waterproofing is done with KÖSTER NB 1 Grey.

KÖSTER NB 1 Grey is a mineral based waterproofing against ground moisture, non-pressurized and pressurized water. KÖSTER NB 1 Grey is resistant to positive and negative side water pressure.



The tiles are applied on top of the waterproofing with common tile adhesive.



The joints also have to be implemented in the tiles.



The horizontal joints are waterproofed with KÖSTER Joint Sealant FS-H. The vertical joints were waterproofed with the putty-like KÖSTER Joint Sealant FS-V.

KÖSTER FS Joint Sealants have a high chemical and mechanical resistance and high resiliency.



The KÖSTER joint and area waterproofing system has proved itself for years at the Veli Efendi Racetrack and still reliably serves the basin as an unfailing waterproofing.

Reliable waterproofing for pipe and cable penetrations

While a wall or area waterproofing can be relatively straightforward in its execution, waterproofing pipe and cable penetrations can be challenging. The main problems are movements in the cables and pipes and the fact that the penetrations are often composed of many different types of materials such as plastics, metal, and concrete. The waterproofing must therefore be plastically (not elastically) deformable so that movements can be absorbed and yet the material retains its adhesion to a wide range of materials. KÖSTER KB-Flex 200 offers all of these properties and can even be used under flowing and pressurized water.



KÖSTER KB-Flex 200 can even be used under flowing and pressurized water.



The material is pressed into place between the cable and the wall with the KÖSTER Special Caulking Gun, immediately and permanently stopping the water flow.



To protect the waterproofing the area is smoothed and protected with KÖSTER KB-Fix 5.



The pipe penetration is now permanently waterproofed.

All advantages at a glance:

- Adhesion to various materials, such as plastic, ceramic, masonry, concrete, wood, metal, and glass.
- Excellent adhesion to dry and wet substrates
- Permanently plastic waterproofing sealant: it never dries out
- Simple application directly from the cartridge
- One component product, no mixing is necessary

KÖSTER Product Range

- | | |
|--|---|
| 1 External basement waterproofing | 7 Bathroom and wet room waterproofing |
| 2 Internal basement waterproofing | 8 Mould control |
| 3 Horizontal barriers/ Restoration of masonry | 9 Floor coatings |
| 4 Crack and hose injection | 10 Façade protection |
| 5 Concrete protection and repair | 11 Balcony and terrace waterproofing |
| 6 Sealing of expansion joints | 12 Roof waterproofing |
| | 13 Water tank and reservoir waterproofing |



KÖSTER BAUCHEMIE AG develops, produces, and supplies a comprehensive range of special construction materials in the areas of water-proofing and concrete repair. Founded in 1982 in Germany, the KÖSTER Group consists meanwhile of 24 companies which are represented in more than 50 countries. It is our policy to offer construction materials of the highest quality, durability and general performance.



Service you can depend on

With our service and distribution network in many countries world-wide we can offer you professional advice and technical support immediately and on the spot. Your required waterproofing materials can be delivered promptly and will protect your property efficiently and lastingly.



For further information, please contact:

KÖSTER
Waterproofing Systems



DEUTSCHE
BAUCHEMIE



KÖSTER BAUCHEMIE AG | Dieselstraße 1–10 | D-26607 Aurich | Germany
Phone: +49 (4941) 9709-0 | Fax: +49 (4941) 9709-40 | info@koster.eu | www.koster.eu